



(REVIEW ARTICLE)



Review of methods for lithium extraction from geothermal brines

Habeeb Dolapo Salaudeen ^{1,*}, Tajudeen Ayinde Salaudeen ², Yahya Onaopemipo ³ and Olubunmi Samuel ⁴

¹ Department of Electrical Engineering and Computer Science EECS, Cleveland State University, Ohio, USA.

² Starfield College, Lagos, Nigeria.

³ Fanshawe College, Ontario, Canada.

⁴ Federal University of Technology Akure, Nigeria.

World Journal of Advanced Research and Reviews, 2024, 24(01), 948–955

Publication history: Received on 06 July 2024; revised on 13 August 2024; accepted on 16 August 2024

Article DOI: <https://doi.org/10.30574/wjarr.2024.24.1.2475>

Abstract

Lithium, a highly reactive and valuable metal, is essential for the clean energy transition, powering electronic devices, electric cars, and energy storage systems. With demand for lithium surging, environmentally responsible and economically viable extraction methods are crucial. Traditional sources include brines and mineral clays, but lithium-ion batteries have become a significant secondary source due to their high consumption of lithium. This review explores various extraction methods from geothermal brines, focusing on conventional techniques like solar evaporation, precipitation, and solvent extraction, highlighting their efficiency and limitations. Advanced electrochemical methods are also discussed, including the use of electrochemical ion pumping and electrodialysis, showcasing their potential for high-purity lithium recovery. Direct Lithium Extraction (DLE) technology, which offers over 90% recovery and reduces impurities by over 99%, is identified as a promising approach. The review underscores the need for large-scale field experiments and the development of new lithium sources to meet growing demand.

Keywords: Lithium extraction; Geothermal brines; Electrochemical methods; Direct Lithium Extraction (DLE); Lithium-ion batteries; Sustainable extraction;

1. Introduction

1.1. Need for sustainable extraction of Lithium

Lithium is a soft, highly reactive, valuable metal with a high electrochemical potential of 3.04 volts. Its demand has skyrocketed and it is now vital to the clean energy transition as its batteries power electronic devices, electric cars, and energy storage, ensuring a consistent and predictable flow of renewable energy. Given that other sources of clean, affordable, and long-term energy, such as solar and wind energy, are seasonal and less reliable at all times and locations, the importance of lithium is well understated. Despite the growing demand for lithium, extracting it in an environmentally responsible and economically viable manner has been challenging. The primary sources of lithium are brines (59%) and mineral clays (25%). Because lithium is a highly reactive element, it cannot be found in its pure state. It is frequently discovered together with other ions such as magnesium, calcium, iron, sodium, potassium, borates, sulphate, and bicarbonates in a wide range of resources, making it extremely challenging to extract lithium from them. To satisfy the growing demand for lithium in a manner that is both environmentally responsible and economically viable, it has become increasingly important to collect and utilise lithium from secondary sources. Recently, lithium-ion batteries have surpassed other sources to become the major resource for recycling lithium. Their consumption of lithium accounts for 35% of the total worldwide amount and is expected to continue growing over the next decade.

* Corresponding author: Habeeb Dolapo Salaudeen

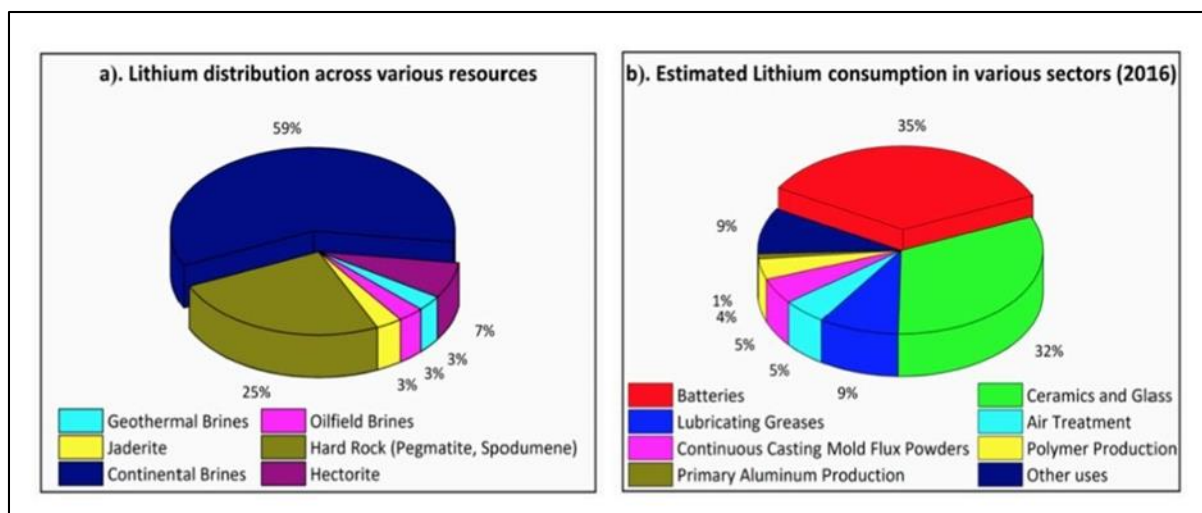

Figure 11 (a) Global distribution of raw lithium resources; and **(b)** Global distribution of lithium consumption for different uses [4]

Other than clay, extracting lithium from minerals that already contain lithium, such as spodumene, lepidolite, zinnwaldite, amblygonite, and petalite, has garnered significant attention recently. For lithium to have a more sustainable future, technological advancements and modifications to the present procedures for extracting and recycling lithium are required [4]. This article reviews some of these methods as discussed by various researchers.

2. Methods of extracting Lithium from Geothermal Brines

2.1. Conventional Methods of Extracting Lithium from Brine.

The traditional methods of brine extraction are not adaptable to the wide variety of brine conditions and need to be painstakingly modified for different brine conditions. However, combining membrane technology with strategies such as precipitation and liquid-liquid extraction has proven to boost the efficiency of conventional lithium extraction processes.

Solar evaporation and other precipitants (Equations 1-5) were utilized in the 1990s to remove coexisting ions, with Li being the most frequent ion to be eliminated. These procedures influence the consistency of the brine, making it either more viscous or more concentrated depending on the technique. However, through a basic process including evaporation and crystallization, the less significant ion Na⁺ may be removed.

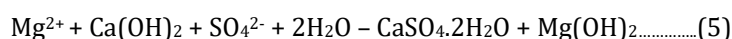
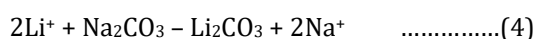
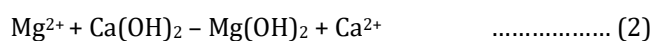
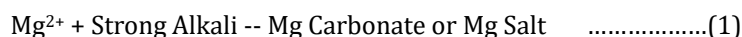

While it is crucial for the process to eliminate Mg²⁺ and Ca²⁺ [3] [6], a high ratio of magnesium to lithium makes it difficult to separate lithium. However, this has improved over time. Later precipitation techniques, such as those employing layered double hydroxides (LDH) intercalated with Mg, have revealed a variety of issues, such as limited Li recovery due to the initial formation of LiAl₂(OH)₆Cl·xH₂O.

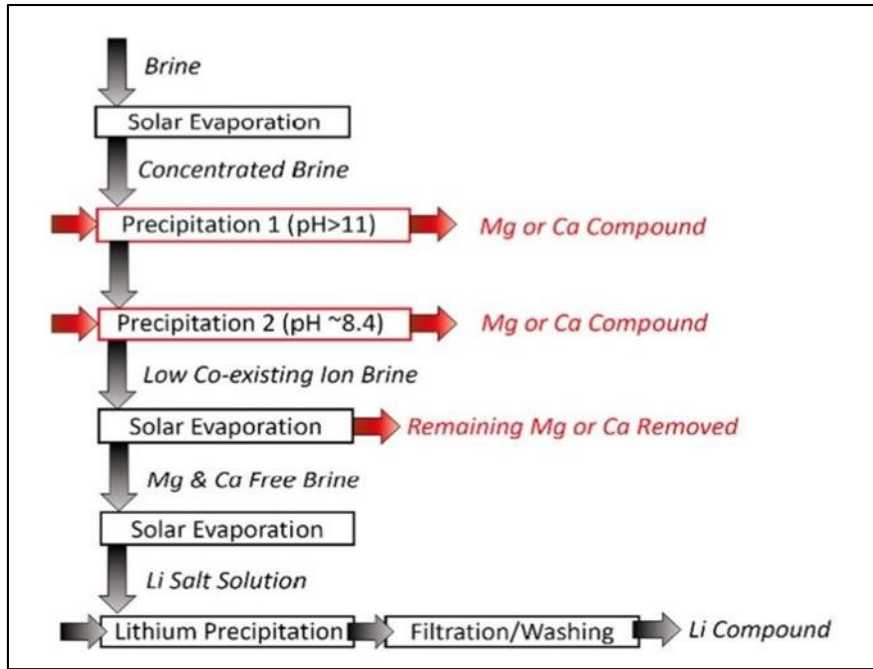

Figure 2 Precipitation process flow diagram of Li extraction

Despite many advances, most precipitation processes are still inefficient and time-consuming [13] [16]. Solvent extraction, on the other hand, has been recognised as a reliable hydrometallurgical separation technology due to its various technological features, such as continuous operation, simplicity, and great flexibility.

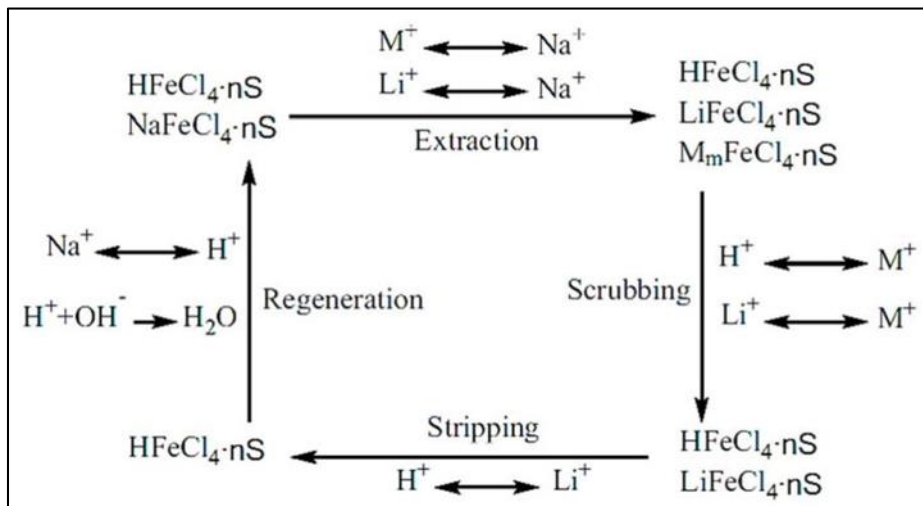
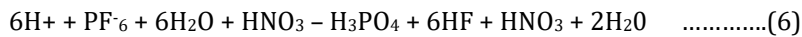

Figure 3 Principle of the solvent extraction process; M denotes Na^+ , K^+ , Mg^{2+} , and Ca^{2+} , while S denotes extractants [11]

The solvent extraction process involves balancing the solutes with organic solvent before being scrubbed to eliminate unwanted solutes. Li^+ is then removed from raffinate using HCl , and the mixture is reused. As a co-extractant, TBP/Kerosene with FeCl_3 requires a low pH to prevent ferric ion hydrolysis. Selecting the proper solvents can be challenging due to several solvents favouring H^+ over Li^+ or having poor attraction affinity for the solute. A more efficient cleaning method becomes a new objective (Sekimoto et al., 2018). The Li extraction rate was greatly enhanced in a continuous process with repeated scrubbing steps assisted by centrifugation. Recent investigations included ionic liquids to make the operation more realistic. Even when dehydrated, they are ionically conductive, non-flammable, and thermally and electrochemically stable. Traditional ILs included hexafluorophosphate (PF_6^-) and bis(trifluoromethyl

sulfonyl)imide (NTf₂⁻). However, this causes hydrolysis of fluoride, which creates hydrofluoric acid as depicted in the equation above [11].

3. Electrochemical Methods

Electrochemical methods provide an efficient and environmentally friendly approach for lithium extraction. These methods, first explored by Kanoh et al. in the early 1990s, transport lithium cations from a solution to battery materials. They are known for their speed, effectiveness, and reduced environmental impact, utilizing less energy compared to other methods. The Li intercalation process, which is the usual approach to charge Li-ion batteries, is the basis for the development of the "capture method." A working electrode made of spinel MnO₂ and a counter electrode made of a Pt wire is also used to produce oxygen and hydrogen. However, this method requires the expensive process of water splitting, which is a significant drawback [2]. This capture and release method can be summarised as follows in the figures below:

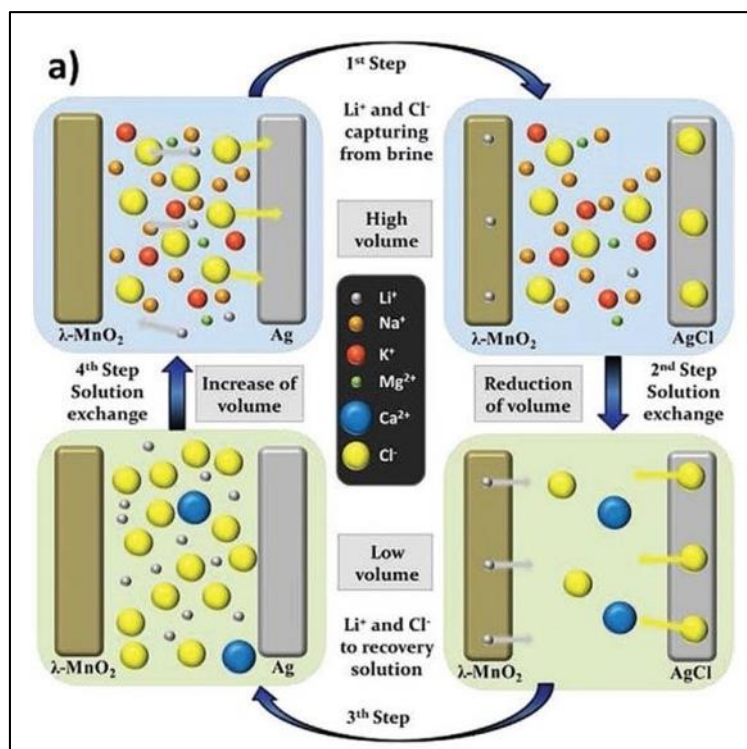

Figure 4 The capture and release method (b) Source: [2]



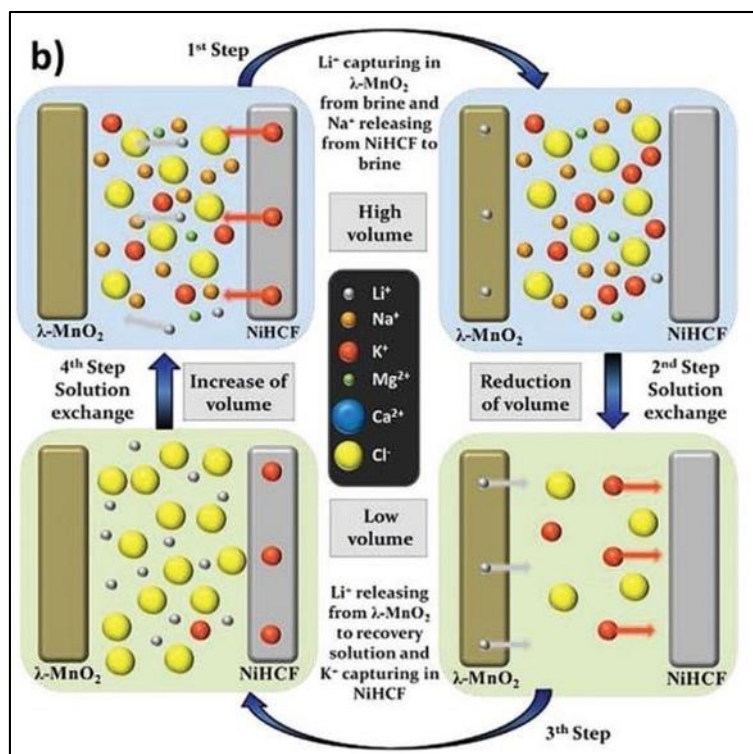
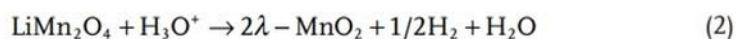

Figure 5 The capture and release method (b) Source: [2]



An alternative electrochemical approach involves the use of an oxidized PPy electrode and lithium-selective LMO to intercalate lithium from natural brine. The process includes:

- **Initial Phase:** The brine electrolyte is replaced with a diluted LiCl recovery solution, and the electrode potential is adjusted.
- **Potential Discharge:** Lithium ions from the LiMn_2O_4 anode and chloride ions from the PPy cathode are discharged.
- **Selective Interaction:** The cathode selectively interacts with Li^+ ions.
- **Recovery:** LiCl is discharged into the recovery electrolyte during the Cl^- exchange at the anode. Lithium ions may diffuse across the layers of $\text{Li}_{1-x}\text{Mn}_2\text{O}_4$ at potentials smaller than 1V [9].

William T. and Dobson [14] also found that "ion-exchange electrodialysis" can be used to electrochemically extract lithium from geothermal brines. This method involves:

Membrane Separation: An electric field helps ions move through a semipermeable membrane, which should not be confused with "electrowinning" (a method not used for lithium extraction).

Lithium-Selective Membrane: Required for extracting lithium from rocks.

Anodes and Cathodes: Same as in lithium-ion batteries, where metal oxides and other molecular sieves or lithium sorbents can coat or produce anodes or cathodes [7] [14].

Calvo [5] reviewed recent progress in using electrochemical ion pumping for lithium extraction, highlighting:

Efficiency: Electrolytic lithium recovery (ELR) systems using water-based electrolytes outperform traditional evaporation methods in terms of extraction rate, energy costs, environmental benefits, and selective lithium-ion extraction.

Flow Techniques: The "flow-through" technique uses less electroactive material than the "flow-by" method, reducing lithium diffusion gradients and improving recovery efficiency.

In the not-too-distant future, scientists will have to develop electrochemical technology that is capable of handling low-voltage, high-current electrical input from the sun. This will facilitate rapid lithium salt recovery with minimal energy usage. Developing electrochemical reactors capable of producing large quantities of Li_2CO_3 , LiOH, LiCl, and other chemicals will be a major focus, requiring significant effort and time.

4. Electrodialysis methods and approaches

Electrodialysis is a widely used technique for extracting lithium from various sources, especially brine. Different research approaches have employed this method, showcasing its versatility and effectiveness in separating lithium from other cations like magnesium. Ball and Boateng used electrodialysis to remove the lithium from multivalent cations, most notably magnesium. Using one or more electrodialysis cycles to treat brine with a wide variety of lithium concentrations and magnesium-to-lithium ratios (up to 60:1). They also use lime precipitation. Membranes made of a styrene divinyl-benzene copolymer (PVC) were modified with sulphonic acid and trimethylamine derivatives and when the pH is under 7, electrodialysis with mixing can be carried out [1]. William T. and Dobson, [14], also used adsorption and electrolysis, first by using adsorbent to bring the concentration of lithium in the brine up to between 1200 and 1500 ppm (ppm), and two rounds of electrodialysis was further used to raise the sorbent's high level of purity to around 1.5%. Zhongwei and Xuheng [18], also used electrodialysis in a brine chamber to recover lithium from manganese filling the brine chamber filled with lithium- and manganese-rich Salt Lake brine, with graphite as the anode and a manganese dioxide (MnO_2) composite membrane as the cathode. Mroczek and colleagues also used electro electrodialysis to extract lithium from desilicated geothermal fluid using aluminium electrodes. According to their experiment, changing voltage, current, fluid temperature, and acidity in an electrodialysis system affects lithium extraction. Also increasing current increased extraction rate, it shortened membrane life [8]. The experimental configuration is seen in Figure 13 below:

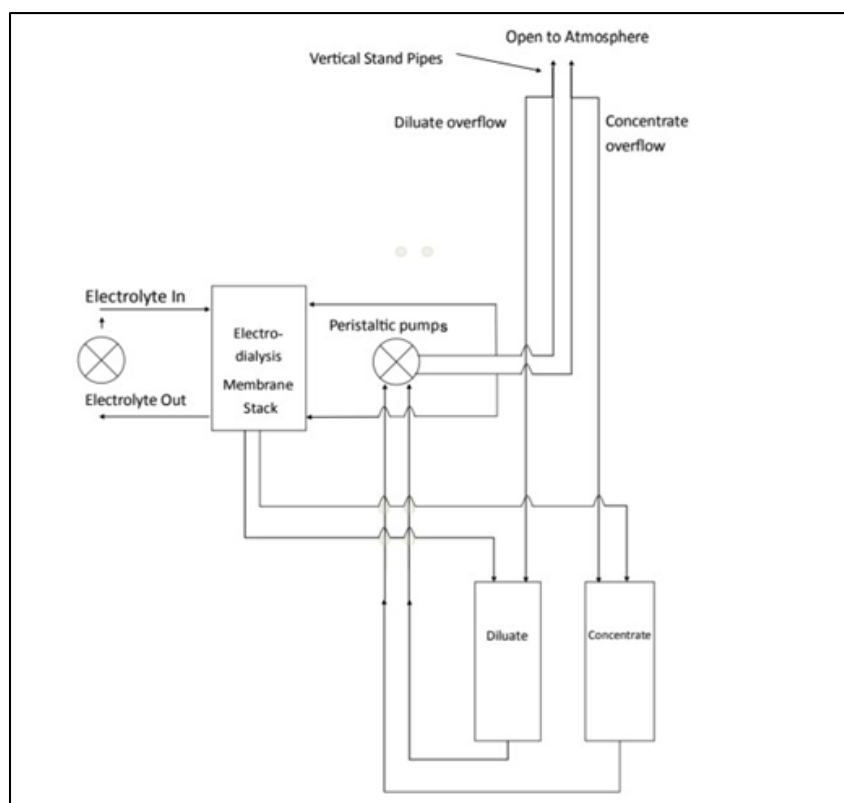

Figure 4 Electrodialysis configuration [8].

In other approaches, researchers have investigated using selective electrodialysis to get lithium out of water using anion-exchange membranes like MA-7500 from Sybron and American Ionac and electrodes made of lithium iron phosphate ($LiFePO_4$) or iron (III) phosphate. However, the pH and salt level of the solution affects how well lithium could be extracted. With a maximum lithium concentration of 38.9 mg/g, more than 95% of the lithium was recovered,

and the Mg^{2+}/Li^+ mass ratio in the feed solution went from 150 to 8 [15]. When it comes to fractionating Mg^{2+}/Li^+ in solutions that have a high starting mass ratio, research showed that selective electro dialysis was a more effective method than nanofiltration. In contrast, the stability of ionic membranes is a key obstacle to the widespread application of electro dialysis for lithium recovery from brines [15].

5. Direct Lithium Extraction (DLE)

DLE is the most recent trend in lithium extraction, and it often competes with the classic method of brine ponds and evaporation. As used by E3 Metals, a Canadian company, Brine is fed into a tank filled with pellets or beads. As the brine flows past it, the Li dissolved in the brine sticks to the pellets, and the Brine leaving the bottom of the tank that is full of the beads is void of Li. This Direct Lithium Extraction (DLE) technology obtains over 90% recovery and increases the concentration of lithium, while reducing impurities by over 99%. This DLE technique was an effective way to reduce impurities. They are also developing DLE technology to extract Lithium from the LEDUC reservoir.

6. Conclusion

A lot of these research shows the potential for extracting lithium from brine, but the primary challenges lie in the economic and environmental viability of these technologies. Direct Lithium Extraction (DLE) appears to be the most promising method, and while electrochemical extraction processes are technically feasible, they are currently limited in their capacity for large-scale lithium recovery. Laboratory studies alone are insufficient to address critical questions about the development and implementation of these technologies. Therefore, larger-scale field experiments with real brines are necessary to advance commercial-scale geothermal lithium resource extraction. Additionally, discovering new sources of lithium will be crucial to meet the increasing demand for lithium-based energy storage solutions.

Compliance with ethical standards

Disclosure of conflict of interest

There are no known competing financial interests or personal interests that could have appeared to influence this paper.

References

- [1] Ball, D.L., and Boateng, D.A.D. (1987). Method for the recovery of lithium from solutions by electro dialysis
- [2] Battistel, A., Palagonia, M.S., Brogioli, D., La Mantia, F., and Trócoli, R. (2020). Electrochemical Methods for Lithium Recovery: A Comprehensive and Critical Review. *Advanced Materials* 32, 1905440. <https://doi.org/10.1002/adma.201905440>
- [3] Bukowsky, H., Uhlemann, E., and Steinborn, D. (1991). The recovery of pure lithium chloride from “brines” containing higher contents of calcium chloride and magnesium chloride. *Hydrometallurgy* 27, 317–325. [https://doi.org/10.1016/0304-386X\(91\)90056-R](https://doi.org/10.1016/0304-386X(91)90056-R)
- [4] Butt, F.S., Lewis, v A., Chen, T., Mazlan, N.A., Wei, X., Hayer, J., Chen, S., Han, J., Yang, Y., Yang, S., et al. (2022). Lithium Harvesting from the Most Abundant Primary and Secondary Sources: A Comparative Study on Conventional and Membrane Technologies. *Membranes* 12, 373. <https://doi.org/10.3390/membranes12040373>
- [5] Calvo, E.J. (2021). Direct Lithium Recovery from Aqueous Electrolytes with Electrochemical Ion Pumping and Lithium Intercalation. *ACS Omega* 6, 35213–35220. <https://doi.org/10.1021/acsomega.1c05516>
- [6] Carson, R.C., and Simandl, J. (1994). Kinetics of magnesium hydroxide precipitation from seawater using slaked dolomite. *Minerals Engineering* 7, 511–517. [https://doi.org/10.1016/0892-6875\(94\)90164-3](https://doi.org/10.1016/0892-6875(94)90164-3)
- [7] Huang, W., Liu, S., Liu, J., Zhang, W., and Pan, J. (2018). 2-Methylol-12-crown-4 ether immobilised PolyHIPES toward recovery of lithium(i). *New J. Chem.* 42, 16814–16822. <https://doi.org/10.1039/C8NJ01961D>
- [8] Mroczek, E., Graham, D., Dedual, G., and Bacon, L. (2015). Lithium Extraction from Wairakei Geothermal Fluid using Electro dialysis. *Proceedings World Geothermal Congress 2015* 6
- [9] Romero, V.C.E., Llano, K., and Calvo, E.J. (2021). Electrochemical extraction of lithium by ion insertion from natural brine using a flow-by reactor: Possibilities and limitations

- [10] Sekimoto, T., Nishihama, S., and Yoshizuka, K. (2018). Extraction of Lithium from Salt Lake Brine with Tributyl Phosphate and an Ionic Liquid. *Solvent Extraction Research and Development, Japan* 25, 117–123. <https://doi.org/10.15261/serdj.25.117>
- [11] Shi, D., Zhang, L., Peng, X., Li, L., Song, F., Nie, F., Ji, L., and Zhang, Y. (2018). Extraction of lithium from Salt Lake brine containing boron using multistage centrifuge extractors. *Desalination* 441, 44–51. <https://doi.org/10.1016/j.desal.2018.04.029>
- [12] Stringfellow, W. T. & Dobson, P. F. (2021) Technology for the recovery of lithium from geothermal brines. *Energies*, 14 (20), 6805
- [13] Tan, H., Zhang, X., He, X., Guo, Y., Deng, X., Su, Y., Yang, J., and Wang, Y. (2018). Utilization of lithium slag by wet-grinding process to improve the early strength of sulphoaluminate cement paste. *Journal of Cleaner Production* 205, 536–551. <https://doi.org/10.1016/j.jclepro.2018.09.027>
- [14] William T., S., and Dobson, P.F. (2021). Technology for the Recovery of Lithium from Geothermal Brines. *Energies* 14, 6805. <https://doi.org/10.3390/en14206805>
- [15] Xianhui, L., Yinghui, M., Weihua, Q., Senlin, S., Chuyang Y., T., and Jianxin, L. (2019). Membrane-based technologies for lithium recovery from water lithium resources: A review. *Journal of Membrane Science* 591, 117317. <https://doi.org/10.1016/j.memsci.2019.117317>
- [16] Yao, W., Wang, J., Wang, P., Wang, X., Yu, S., Zou, Y., Hou, J., Hayat, T., Alsaedi, A., and Wang, X. (2017). Synergistic coagulation of GO and secondary adsorption of heavy metal ions on Ca/Al layered double hydroxides. *Environmental Pollution* 229, 827–836. <https://doi.org/10.1016/j.envpol.2017.06.084>
- [17] Zavahir, S., Elmakki, T., Gulied, M., Ahmad, Z., Al-Sulaiti, L., Shon, H.K., Chen, Y., Park, H., Batchelor, B., and Han, D.S. (2021). A review on lithium recovery using electrochemical capturing systems. *Desalination* 500, 114883. <https://doi.org/10.1016/j.desal.2020.114883>
- [18] ZHAO, Z., and LIU, X. (2015). Method and device for extracting and enriching lithium. *Korean Society of Sensors Academic Journal English homepage*.